

NPT Active 1 Door Digital Freezer, 670lt (-22/-15) - Remote

ITEM # _____

MODEL # _____

NAME # _____

SIS # _____

AIA # _____



110124 (NPT71FFR)

1-door freezer 670lt, -22-15°C,
digital, remote, AISI 304

Short Form Specification

Item No.

Full door freezer entirely constructed in 304 AISI stainless steel with bottom panel in anti-corrosive material. Large digital white-digit display with cabinet temperature display and setting. HACCP-compliant control with alarms and history. Automatic defrost activates only when required with automatic evaporation of defrost water. Optimized back to front forced air flow and removable air conveyors provide even temperature distribution and fast cooling in any conditions. Fitted with 75 mm-thick cyclopentane insulating foam. On-site reversible door features lock and door microswitch to switch off the fan when the door is opened. Hidden evaporator to guarantee higher storage capacity and less corrosion problems. Remote refrigeration unit; ventilated operation; Internal LED light. Supplied with n. 4x2/1GN Rilsan coated grids and n. 4 sets of 2 stainless steel grid runners. Prearranged to fit RS485 port to facilitate connection to a remote computer and integrated HACCP systems.

Main Features

- Freezer model has operating temperatures that can be adjusted from -22 to -15 °C.
- Large storage area suitable to contain 2/1 GN grids or shelves on anti-tilt runners.
- Cabinet fitted with up to 75 mm thickness of cyclopentane insulation for best insulating performance with 100% environmental protection (thermal conductivity: 0,020 W/m*K).
- 60 mm-thick insulation covering the evaporator can be easily removed with a single operation.
- The Active Defrost activates the defrost cycle only when necessary and only for the required time.
- Back to front forced air flow and removable air conveyors provide even temperature distribution and fast cooling in any conditions.
- Internal structure with 44 charging positions available to host grids, ensuring higher net capacity and a greater storage space.
- Prearranged to fit RS485 port to facilitate connection to a remote computer and integrated HACCP systems.
- Tropicalized unit.

Construction

- Interior base with rounded corners, pressed from a single sheet.
- Lockable door.
- Refrigerant type: R404a.
- Remote refrigeration unit.
- Constructed from the highest quality AISI 304 Stainless steel.
- Easy access to the main components for maintenance.
- Stainless steel runners and supports easily disassembled.
- The rounded internal corners, the easily removable runners, grids and air conveyors allow for ease of cleaning and high hygiene standards.
- Anti-corrosion bottom material avoids any damage that may be caused to the cabinet by aggressive detergents employed to clean the floors.

User Interface & Data Management

- Large digital white-digit display with cabinet temperature display and setting. Bluetooth technology included allows to keep HACCP historical data and download them through the app.
- Zanussi Professional Fridge Control APP makes the life easier for our customers:
 - Monitor safety of preservation process thanks to HACCP data & alarms for precise control
 - Save time and easy data management having the possibility to send the HACCP information in excel format directly to e-mail address
 - Quick operations: set the cabinet temperature/turbocooling and set date/hour
- Large digital white-digit display with cabinet temperature display and setting, activation of turbo frost cycle (to rapidly cool warm loads) and possibility to activate manually the defrost cycle.

Sustainability

- CFC and HCFC-free insulation.

APPROVAL: _____



NPT Active 1 Door Digital Freezer, 670lt (-22/-15) - Remote

- Interior LED light to save energy and for best internal visibility.
- Door switch stops the fan when door is opened to avoid cold air exiting the cell, thus saving energy.
- Removable triple-chamber balloon magnetic gasket to improve insulation and reduce energy consumption and ease of cleaning.



**NPT Active
1 Door Digital Freezer, 670lt (-22/-15) - Remote**

The company reserves the right to make modifications to the products without prior notice. All information correct at time of printing.

2026.04.20

Included Accessories

- 4 of 2/1GN grey rilsan grid with 2 runners PNC 881020

Optional Accessories

- 2 stainless steel runners for refrigerated cabinets (Marine) PNC 880242
- Set of 8 GN1/1 PVC containers for fish PNC 880243
- Spacer for 670 lt and 1430 lt refrigerated cabinets PNC 880248
- Pedal opening for cabinets PNC 880324
- 1/1GN plastic container with false bottom PNC 880705
- Kit to fit 10 pastry trays (400x600mm) PNC 881003
- 2/1GN grey rilsan grid PNC 881004
- 2/1GN aisi 304 stainless steel grid PNC 881016
- 2/1GN 304 AISI stainless steel grid with 2 runners PNC 881018
- Set of 2 stainless steel runners for 670/1430lt refrigerators and freezers PNC 881021
- 2/1GN pvc container with lid and 2 runners PNC 881039
- 2/1GN perforated shelf PNC 881042
- 1/1GN rilsan steel wire basket h=150mm PNC 881043
- 2/1GN grey rilsan basket+2 runners h=150mm PNC 881047
- Remote unit for 670lt cabinets and freezer counters - 2 and 3 compartments PNC 881123
- IoT module for refrigerated cabinets and counters PNC 881298

Front

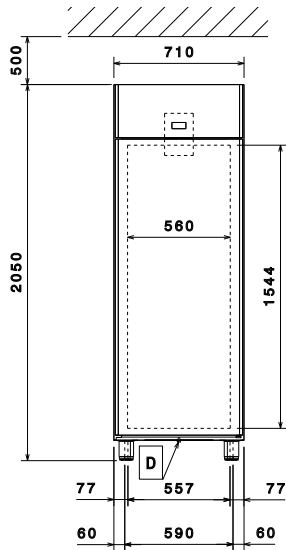

Side

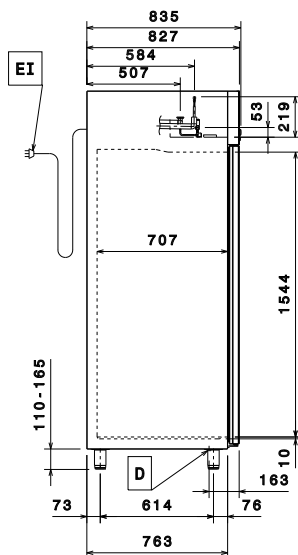

EI = Electrical inlet (power)
RI = Refrigerant Inlet
RO = Refrigerant Outlet

Top

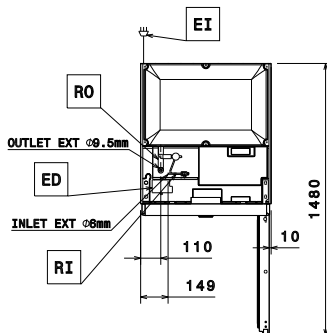

Electric

Supply voltage: 220-240 V/1 ph/50/60 Hz
Electrical power, max: 0.16 kW

Capacity:

Number and type of grids (included): 4 - GN 2/1

Key Information:

Door hinges:
External dimensions, Width: 710 mm
External dimensions, Depth: 835 mm
External dimensions, Depth with Doors Open: 1480 mm
External dimensions, Height: 2050 mm
Number and type of doors: 1 Full
Type of external material: 304 AISI
Type of internal material: 304 AISI
Internal panels material: 304 AISI
Number of positions & pitch: 44; 30 mm
Gross capacity: 670 lt

Refrigeration Data

Control type: Digital
Refrigeration type: R404A;R452A
Suggested refrigeration power: 971 W
Condition at evaporation temperature: -20 °C
Condition at condensation temperature: 55 °C
Condition at ambient temperature: 43 °C
Connection pipes (remote) - outlet: 9.5 mm
Connection pipes (remote) - inlet: 6 mm

*Note:

Ref. Power calculated at a linear distance of 15 mt (piping)